



A brand you can trust

# Loading Technology

dock levellers, dock shelters,  
loading houses & accessories





International brand



About us.....	4
PROMStahl's mission.....	5
Our range.....	6-7
Our tools.....	8
Hydraulic dock levellers.....	9
PS - Hydraulic Dock Leveller with Swing Lip.....	10
PAS - Loading Ramp with Swing Lip Leveller.....	11
PT - Hydraulic Dock Leveller with Telescopic Lip.....	12
PAT - Loading Ramp with Telescopic Lip Leveller.....	13
PTU - Hydraulic Dock Leveller with Segmented Telescopic Lip.....	14
Control panels.....	15
Frame types.....	16-17
Mechanical dock levellers.....	18
PECO - Mechanical Mini Dock Leveller.....	19
Mechanical dock levellers and dock plates.....	20-21
Dock shelters.....	22-24
PL - Loading house.....	25
About loading house.....	26
Accessories and other products.....	27
Types of accessories.....	28-31
The right solution.....	32-33
Our certificates.....	34



## ABOUT US



## PROMStahl – a brand you can trust

PROMStahl is one of the leading manufacturers of loading dock equipment in Europe, and its quality, reliability and service has been trusted by companies from all over the globe since 2007. With its main sales office in Gehrden, Germany and the support of sales offices and authorised distributors worldwide, PROMStahl can offer solutions for every loading bay requirement.

PROMStahl specialises in the design, manufacture,

installation and service of loading dock equipment including – hydraulic dock levellers, mechanical dock levellers, dock shelters, dock houses and a wide range of loading bay accessories. The extensive knowledge and experience of the entire team, as well as the continuous product and technology development allows PROMStahl to provide cost-effective solutions, high quality products and reliability as a long-term partner.

## PROMSTAHL'S MISSION



PROMStahl is a part of the Immobile Group (GKI), which is a publicly traded company on the Warsaw Stock Exchange that invests in companies with a high growth potential. Its current portfolio includes companies in sectors of the heavy steel industry, hotels, as well as residential and commercial real estate development. PROMStahl's mission is to exceed its customers' expectations by providing cost-effective solutions, high quality and innovative products to the logistics industry. PROMStahl strives to be the trusted brand for every loading dock solution. No job is too big or too small.

**Products manufactured by PROMStahl comply with all European standards, and our dock levellers have successfully undergone load tests in accordance with the German Association for Technical Inspections (TÜV) regulations based on the current EN1398 standard for dock levellers.**







## Product range

1. PS pg. 10  
 2. PAS pg. 11  
 3. PT pg. 12  
 4. PAT pg. 13

5. PTU pg. 14  
 6. PECO pg. 19  
 7. PPV pg. 20  
 8. PPF pg. 21

9. PMV pg. 23  
 10. PWI pg. 24  
 11. PMN pg. 24  
 12. PMK pg. 23

13. PMS pg. 23  
 14a. PL pg. 26  
 14b. PL pg. 26  
 15. PAR pg. 29





16. PGF pg. 29  
 17. PGS pg. 29  
 18. PGB pg. 29  
 19. PGV pg. 29

20. PGFS pg. 29  
 21. PEF pg. 30  
 22. PEK pg. 30  
 23. PEFE pg. 30

24. PEKE pg. 30  
 25. GuardBLOCK pg. 31  
 26. PAFP pg. 30  
 27. PBEA pg. 31

28. PBEA pg. 31  
 29. PZK pg. 31  
 30. Scissor table pg. 29

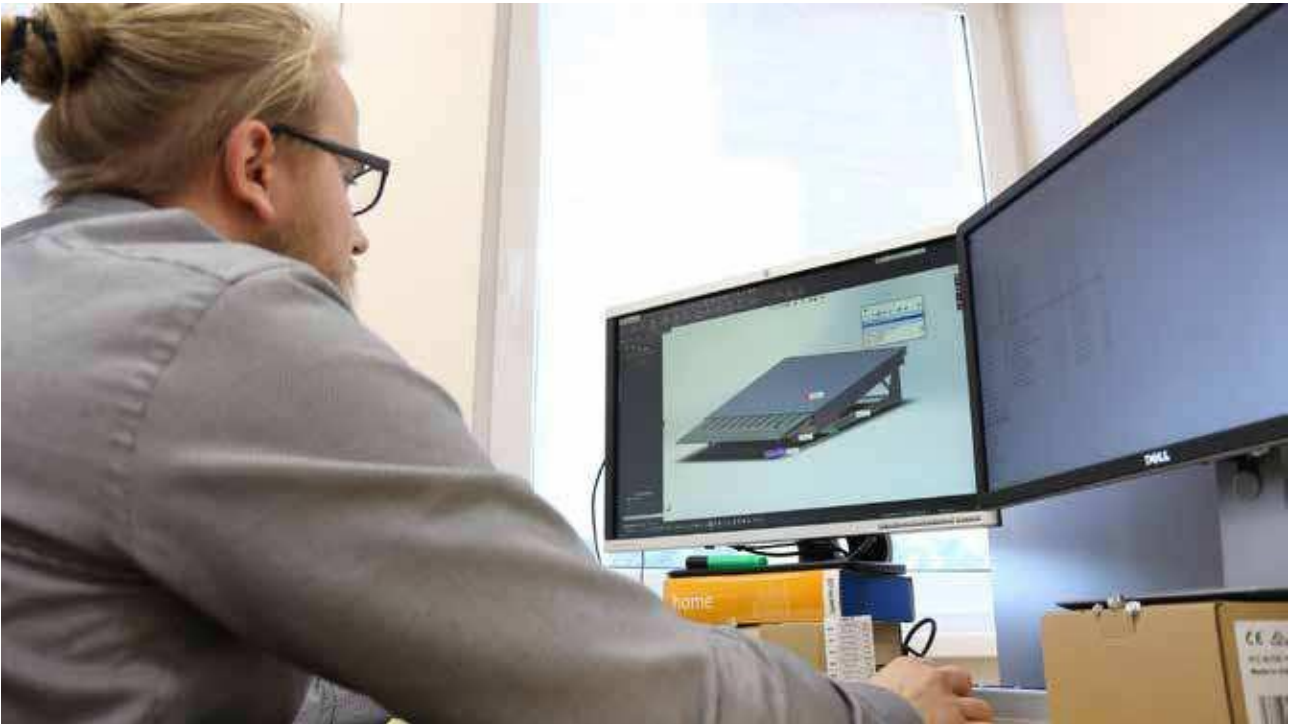

We endeavour to exceed our clients expectations. It is important to us that we can supply the right solution for every scenario taking into consideration the specific loading and unloading requirements, the type of industry, the existing infrastructure, as well as the client's specific needs. For this reason we offer a diverse range of solutions which can be customised and modified to suit almost every application. For the convenience of our clients, we have also developed tools to help in selecting the right loading bay equipment.

## PROMCAD



PROMCAD is a program allowing technical drawings to be downloaded in multiple formats and match accessories required for the specific project. It not only includes technical product drawings but also the technical installation drawings to make this an invaluable tool to experts in the loading dock industry.

## PROMCalculation



PROMCalculation is a program which can be used to calculate the prices of standard PROMStahl products. It also allows you to view the range of our products and to weigh up the best option for your requirements. If you require bespoke solutions for your loading bay equipment, our friendly, trained technical advisors will be willing to help.



# HYDRAULIC DOCK LEVELLERS

Hydraulic dock levellers are a safe and effective way to bridge the gap as well as compensate the difference in height between the unloading vehicle and the warehouse floor. Our dock levellers are available with a swing-lip or with a telescopic lip and can be ordered in industry-standard sizes or as bespoke projects. We have a solution for every loading bay requirement and all our products meet the EN1398 standard for loading docks.

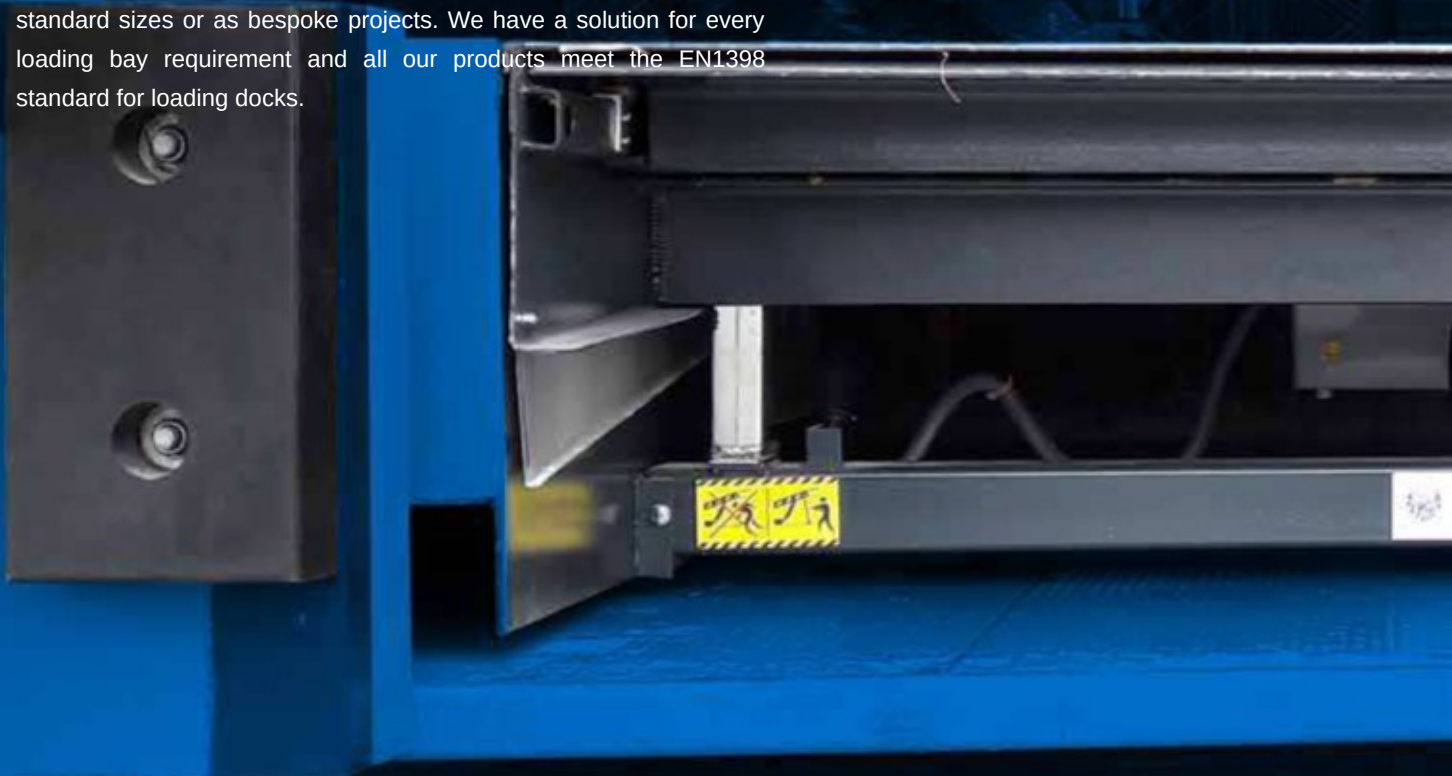

# PS - Hydraulic Dock Levelle

## PS - Hydraulic Dock Leveller with Swing Lip

Our PS Hydraulic Dock Leveller with Swing Lip is a safe and efficient solution for busy loading bays where quick loading and unloading of standard-size trucks is necessary. Thanks to the robust swing lip, the gap between the vehicle and the building can safely be bridged while compensating for the height difference, even during loading and unloading.

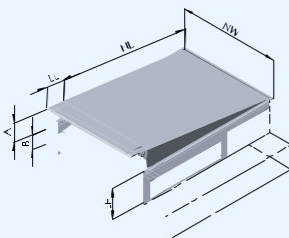
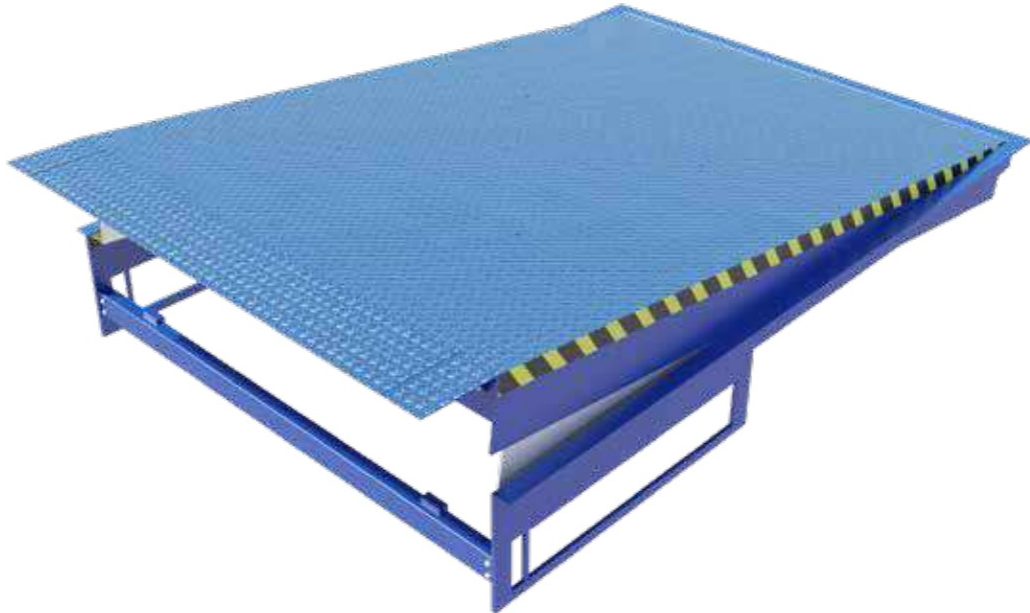

### Standard parameters:

Nominal lengths (NL):	1750, 2000, 2500, 3000, 3500, 4000, 4500 mm
Nominal width (NW):	1750, 2000, 2100, 2200, 2250, 2400 mm
Leveller heights (LH):	600, 700, 800, 900 mm
Lip lengths (LL):	400, 500 mm
Rated Load Capacity :	6 ton (60kN)
Operating ranges above the level (A):	0 – 620 mm
Operating ranges below the level (B):	0 – 350 mm

### Options:

Fall-Guard	One piece platform surface
Anti-slip protective coating	Insulation Solutions Available
Lip tapered 125 mm	PVC curtain for tail lift
Lip bevelled 100mm	Hot-Dip Galvanising
Lip 500 mm	
Top plate thickness 8/10mm	



## PAS – Loading Ramp with Swing Lip Leveller

The PAS Loading Ramp with Swing Lip Leveller is a combination of the PS Dock Leveller integrated into a self-supporting frame. With all the advantages of the PS Dock Leveller, the PAS Loading Ramp is a cost-effective solution to add a loading bay to an existing premises and to maximise the internal storage space of the building. This loading ramp can be used with a loading house to make a complete loading bay solution.

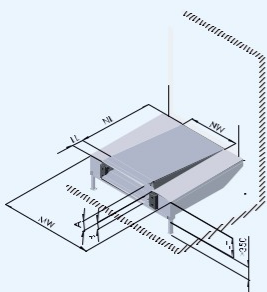
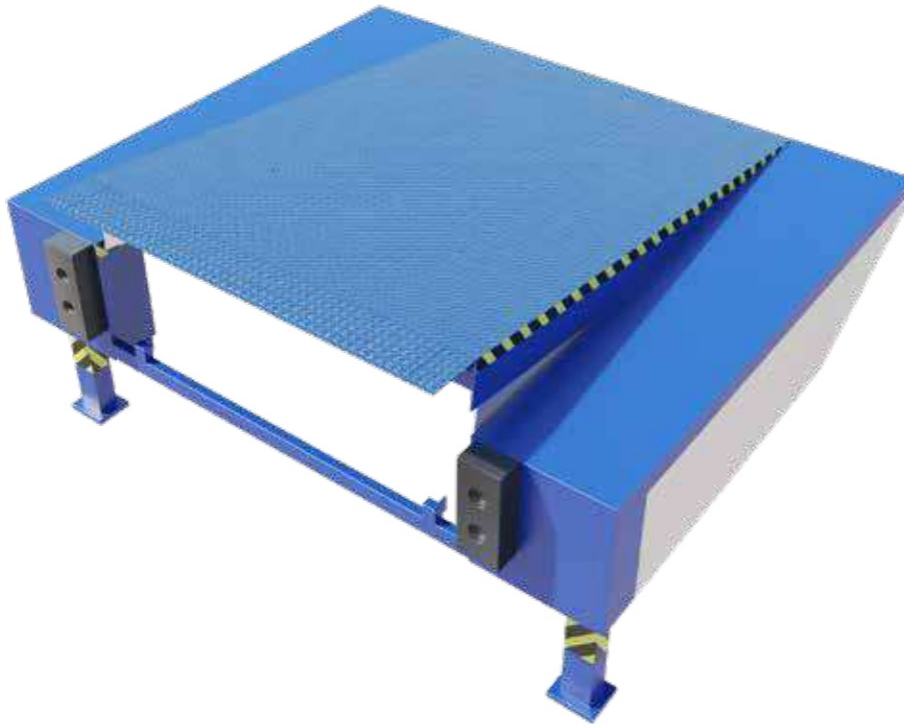

### Standard parameters:

Nominal lengths (NL):	2000, 2450, 3000, 3500 mm
Nominal width (NW):	2000, 2200 mm
Leveller heights (LH):	700, 800 mm
Lip lengths (LL):	400, 500 mm
Loading ramp module with (MW):	3300, 3500 3600 mm
Rated Load Capacity:	6 ton (60kN)
Operating ranges above the level (A):	0 – 410 mm
Operating ranges below the level (B):	0 – 360 mm

### Options:

Fall-Guard	One piece platform surface
Anti-slip protective coating	PVC curtain for tail lift
Lip tapered 125 mm	Hot-Dip Galvanising
Lip bevelled 100mm	
Lip 500 mm	
Top plate thickness 8/10mm	

# PT - Hydraulic Dock Leveller

## PT - Hydraulic Dock Leveller with Telescopic Lip

Our PT Hydraulic Dock Leveller with Telescopic Lip is the ideal solution when positioning the lip on the back of the vehicle must be precise. Thanks to the extendable and retractable lip, you can achieve a larger reach and position the lip in the most effective position to allow safe and efficient loading and unloading of the vehicle while compensating for the height difference between the vehicle and the building.

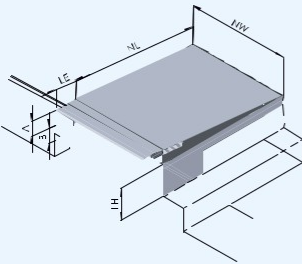
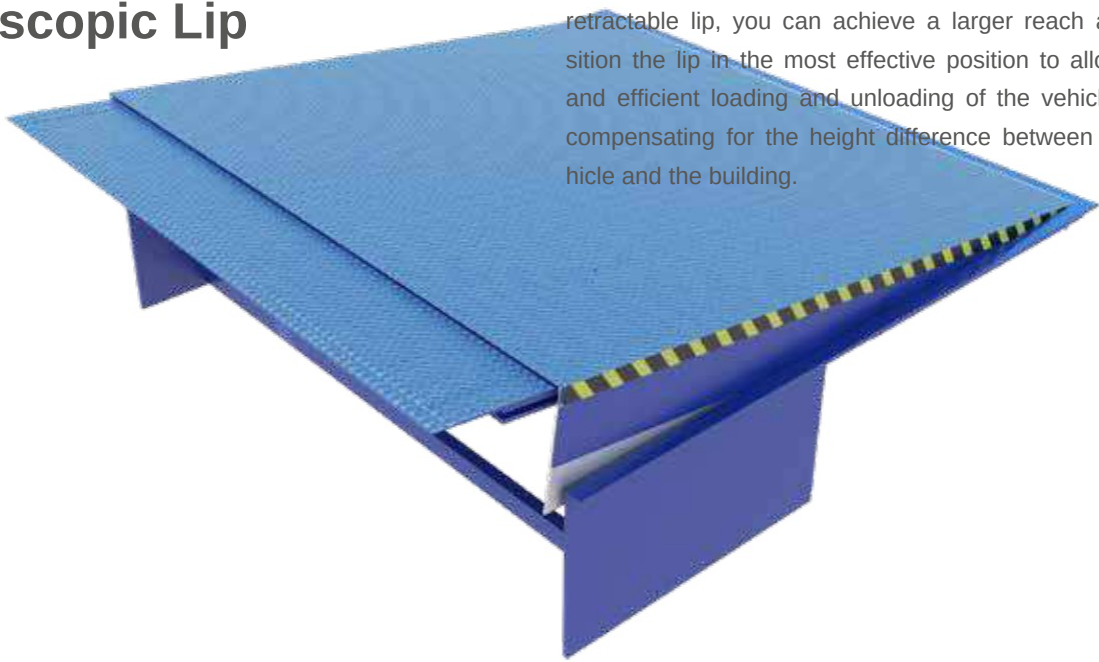

### Standard parameters:

Nominal lengths (NL):	1750, 2000, 2500, 3000, 3500, 4000, 4500 mm
Nominal width (NW):	1750, 2000, 2100, 2200, 2250, 2400 mm
Leveller heights (LH):	600, 700, 800 mm
Lip lengths (LE):	500, 1000 mm
Rated Load Capacity:	6 ton (60kN)
Operating ranges above the level (A):	0 – 590 mm
Operating ranges below the level (B):	0 – 480 mm

### Options:

Fall-Guard	One piece platform surface
Anti-slip protective coating	Insulation Solutions Available
Lip tapered 125 mm	PVC curtain for tail lift
Lip bevelled 100mm	Hot-Dip Galvanising
Lip 1000 mm	
Top plate thickness 10/12mm	



# PAT – Loading Ramp with Telescopic Lip Leveller

The PAT Loading Ramp with Telescopic Lip Leveller is a combination of the PT Dock Leveller integrated into a self-supporting frame. With all the advantages of the PT Dock Leveller, the PAT Loading Ramp is a cost-effective solution to add a loading bay to an existing premises and to a maximise the internal storage space of the building. This loading ramp can be used with a loading house to make a complete loading bay solution.

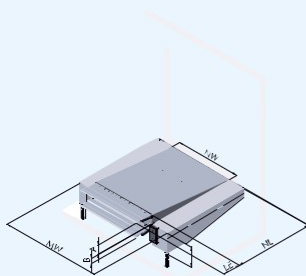
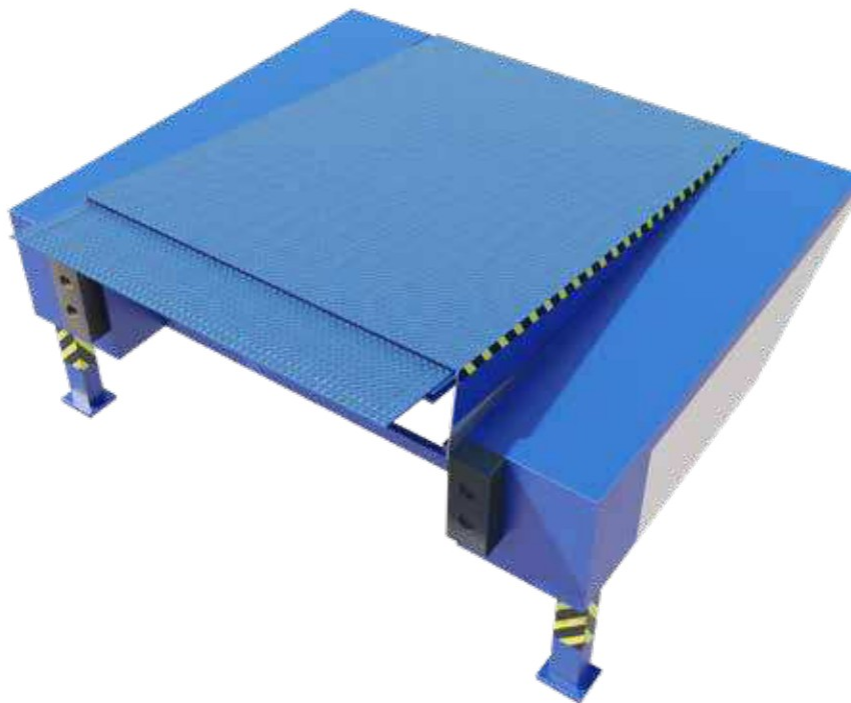

### Standard parameters:

Nominal lengths (NL):	2000, 2250, 2450, 3000, 3500 mm
Nominal width (NW):	2000, 2200, 2250, 2400 mm
Leveller heights (LH):	700, 800 mm
Lip lengths (LE):	500, 1000 mm
Loading ramp module with (MW):	3300, 3500 3600 mm
Rated Load Capacity:	6 ton (60kN)
Operating ranges above the level (A):	0 – 590 mm
Operating ranges below the level (B):	0 – 480 mm

### Options:

- Fall-Guard
- Anti-slip protective coating
- Lip tapered 125 mm
- Lip bevelled 100mm
- Lip 1000 mm
- Top plate thickness 10/12mm
- One piece platform surface
- Insulation Solutions Available
- PVC curtain for tail lift

# PTU - Hydraulic Dock Leveller

## PTU - Hydraulic Dock Leveller with Segmented Telescopic Lip

The PTU Hydraulic Dock Leveller with Segmented Telescopic Lip allows the flexibility of loading and unloading standard trucks and delivery vans using the same loading dock leveller. When selected for use with a delivery van, only the 1200mm segmented lip is extended and the weight on the van is hydraulically reduced to approximately 100kg to avoid damaging the vehicle. In other circumstances it can be used in the same way as a PT Dock Leveller.

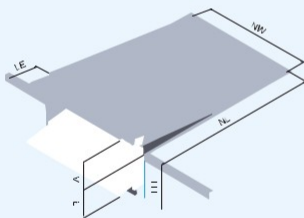
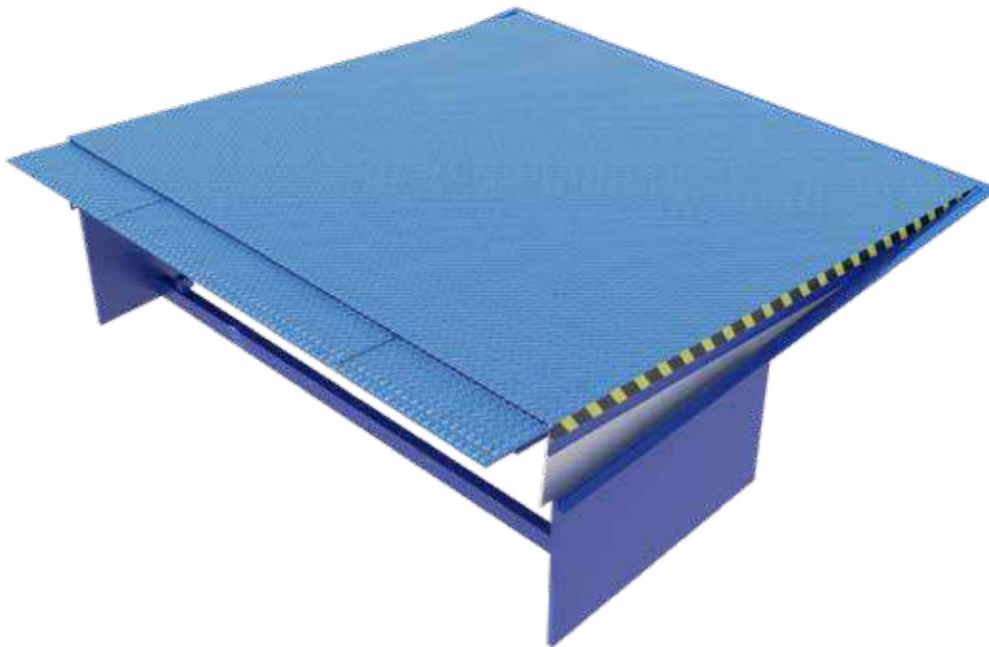

### Standard parameters:

Nominal lengths (NL):	3000, 3500, 4000, 4500 mm
Nominal width (NW):	2000 mm
Leveller heights (LH):	800, 900, 950 mm
Lip lengths (LE):	500, 1000 mm
Rated Load Capacity:	6/2 ton (60/20kN)
Operating ranges above the level (A):	0 – 600 mm
Operating ranges below the level (B):	0 – 720 mm

### Options:

Fall-Guard	Top plate thickness 10/12mm
Anti-slip protective coating	One piece platform surface
Lip tapered 125 mm	Insulation Solutions Available
Lip bevelled 100mm	PVC curtain for tail lift
Lip 1000 mm	Hot-Dip Galvanising



# Control panel

The control panels for PROMStahl dock levellers have been designed to not only simplify the loading and unloading process, but to also provide even greater safety and efficiency for the user. We offer a standard version as well as versions which can be adapted to provide multiple functions. The control panel allows you to raise the dock leveller platform and extend the platform lip to its working position, and the auto-return button allows the dock leveller to go from the working position to the resting position at the push of a button. The control panel has the ability to control pneumatic dock shelters, sealing curtains and doors and can easily be set-up to work with additional safety products including vehicle sensors, door sensors and traffic lights.

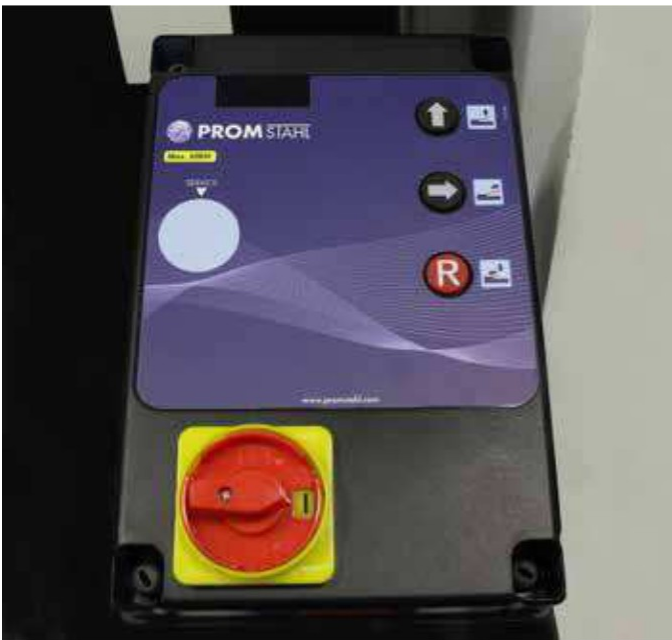

## Control panels

Opcja:	Basic PS	Basic PT	Standard PS/PT
Buttons to control leveller operation	YES	YES	YES
Button to allow auto-return to resting position	NO	YES	YES
Locking the leveller with door sensor	YES	YES	YES
Automatic door locking while leveller is working	NO	YES	YES
Wheel chock sensor	YES	YES	YES
Pneumatic shelter control	NO	NO	OPTION
Sealing curtain control	NO	NO	OPTION
Buttons to control the door	NO	NO	OPTION
Support for traffic lights	NO	NO	YES
Vehicle sensor	NO	NO	YES
Position sensor of the leveller	NO	NO	YES
Dock lighting control	NO	NO	YES

# Frame types

## T-LEVELLER FRAME TO BE EMBEDDED IN CONCRETE

Fast and clean installation in one step.

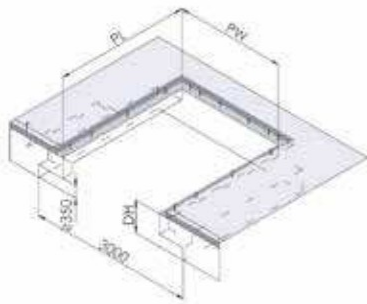

with tail-lift recess

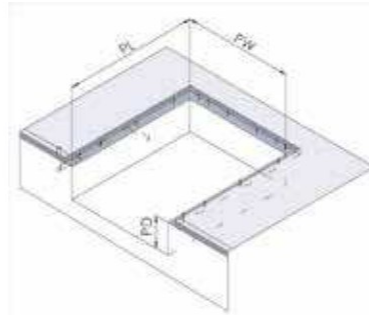

without tail-lift recess

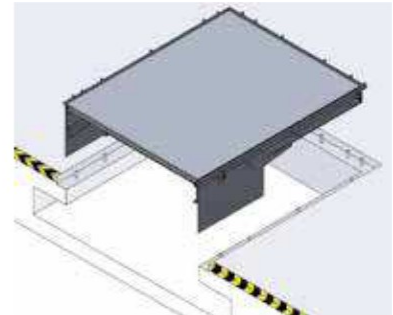

- PL** Pit length
- DH** Pit width
- PW** Dock height
- PD** Pit depth

## W-LEVELLER FRAME TO BE WELDED IN

W leveller frame to be welded in. The frame can be mounted to the floor slab already before installation of the dock leveller. The leveller is then just welded to the pre-installed frame. Pit preparations are identical for T and W-type frames so that maximum flexibility is guaranteed.

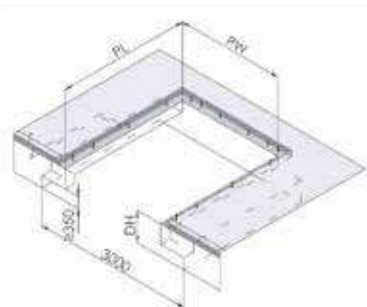

with tail-lift recess

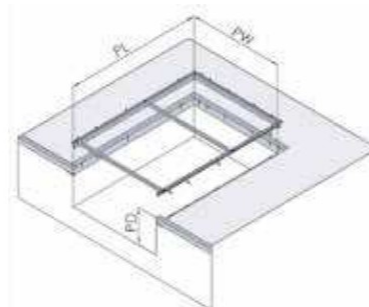

without tail-lift recess

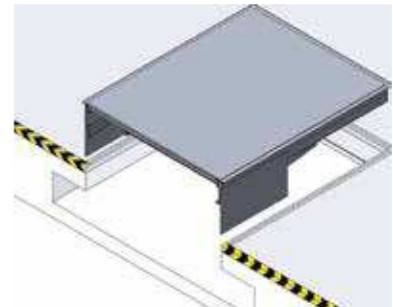

- PL** Pit length
- DH** Pit width
- PW** Dock height
- PD** Pit depth

## F-FLAT FRAME TO BE WELDED IN

For easy replacement of existing dock levellers. With the F-type frame the existing leveller is removed from the pit and replaced by a correspondingly narrower and shorter one. The existing frame can still be used if its load capacity is sufficient. Thus, concrete work is not required.

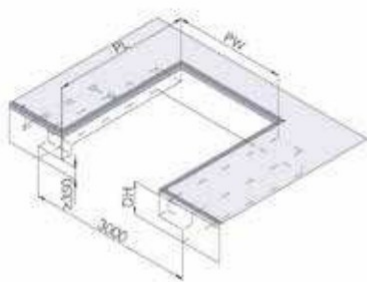

with tail-lift recess

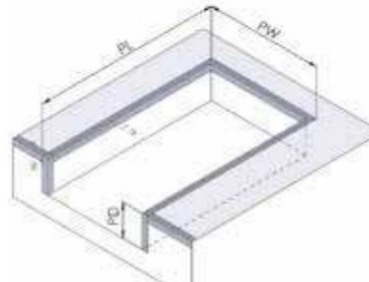

without tail-lift recess

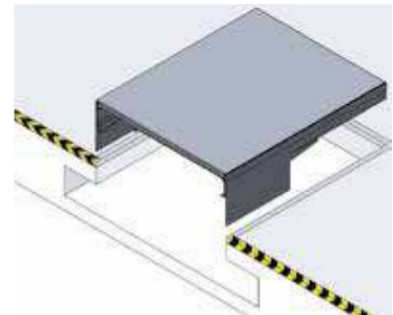

- PL** Pit length
- DH** Pit width
- PW** Dock height
- PD** Pit depth

## P-FRAME MOUNTED IN THE PIT

Fast and cost-effective installation of the leveller. Recommended for levellers without tail-lift recess. without tail-lift recess.

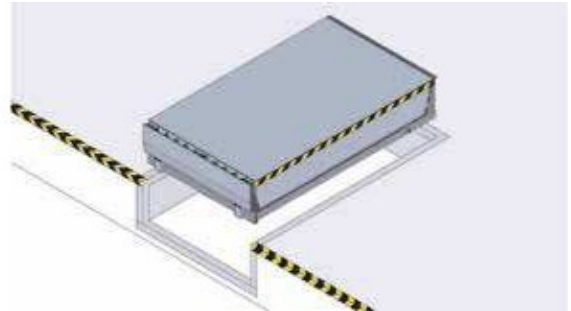
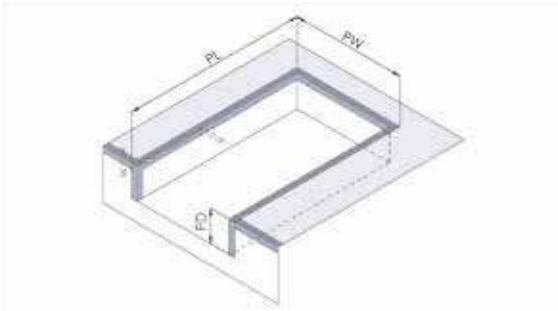

- with tail-lift recess
- PL** Pit length,
  - PW** Pit width
  - PD** Pit depth

## B-BOX FRAME

No need to prepare a standard installation pit. Preparation of the building floor slab is much easier as cladding work is not necessary.

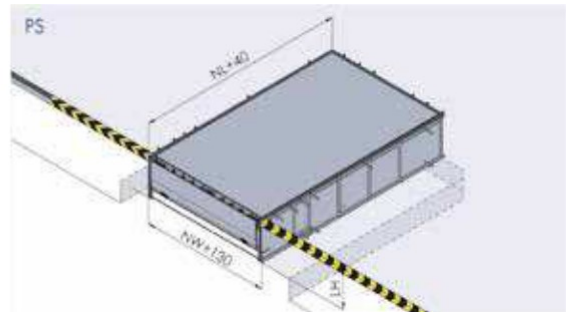
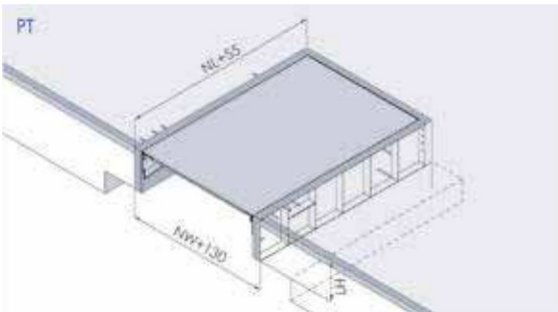

- NL** Nominal length
- LH** Nominal width
- NW** Leveller height

- NL** Nominal length
- LH** Nominal width
- NW** Leveller height

## Electrical preparations (by others)

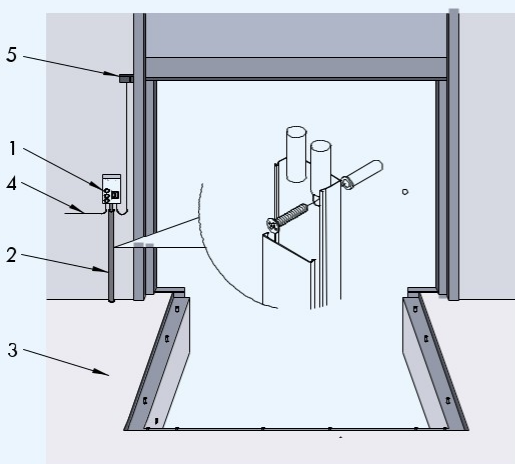

- 1 Electrical control unit (supplied)
- 2 Cable conduit (by others)
- 3 **Wire conduit, Minimum internal diameter 50 mm, angled pipe  $\geq 45^\circ$  (by others)**
- 4 **Mains supply:**

3/N/PE AC 50 Hz	<b>Mains fuse:</b>	<b>Motor power:</b>
400 V/ CEE 16A	DO 10 A gL	0,75 kW (PS)
		1,5 kW (PT)
- Cable:**

3 x 0,75 mm <sup>2</sup>	<b>Motor cable:</b>
7 x 0,75 mm <sup>2</sup> (PT)	4 x 1,5 mm <sup>2</sup>
- 5 Door/dock leveller light sensor\*

\*Option



# MECHANICAL DOCK LEVELLERS

In situations where there is minimal difference between the floor height and the unloading vehicle, a hand-operated, mechanical dock leveller may be the solution. PROMStahl offer a wide range of drawbridges and dock plates that can be installed in new or existing buildings and can be simply operated by one person.

# PECO - Mechanical Mini Dock Leveller

The PECO mechanical dock leveller is an economical solution for loading and unloading vehicles with minimal height differences between the truck bed and the dock. This makes it the perfect solution for situations where the delivery vehicle is the same for the entire fleet.

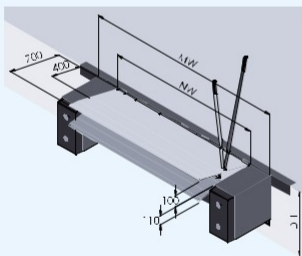

### Standard parameters:

Nominal lengths (NL):	485 mm
Nominal width (NW):	1750, 2000, 2250 mm
Rated Load Capacity:	4, 6 ton (40, 60kN)
Operating ranges above the level (A):	0 – 600 mm
Operating ranges below the level (B):	0 – 110 mm

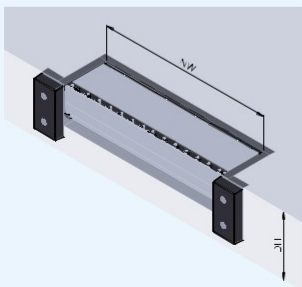

### Options:

- Steel lip
- Sectional steel lip
- Aluminum sectional lip
- Hot dip galvanizing

- Frame types:
- frame for external installation (R)
  - model for pit installation (P)



# Drawbridge Levellers



## PPF/PPFA - Stationary Drawbridge Leveller

The PPF/A stationary drawbridge leveller is a mechanically-operated leveller suitable for internal or external loading docks with small to medium height differences to be compensated. Thanks to the large pressure springs which support the weight of the leveller, this product can safely be operated by one person. When the leveller is not in use, it is safely stored in a vertical position thanks to an automatic safety device.



## PPV/PPVA - Laterally Sliding Drawbridge Leveller

The PPV/A laterally sliding drawbridge leveller is a mechanically-operated leveller suitable for internal or external loading docks with small to medium height differences to be compensated. The leveller is installed on a sliding rail allowing the leveller to be moved laterally across the dock. Thanks to the large pressure springs which support the weight of the leveller, this product can safely be operated by one person. When the leveller is not in use, it is safely stored in a vertical position thanks to an automatic safety device.



## PKBS - Laterally Sliding Drawbridge Leveller

The PKBS laterally sliding drawbridge leveller made of durable weatherproof aluminium alloy and is designed for bridging loading areas with small or medium differences in height and can be operated by one person. This leveller slides laterally and is stored vertically at the edge of the dock when not in use. It has a load capacity of 40 kN. The maximum difference in height that can be compensated is 135 mm. The automatic lock and release system prevents the leveller from accidentally dropping.



## PSKB - Slidable Drawbridge Leveller

The PSKB Slidable Drawbridge Leveller is designed for bridging

medium differences in height and can be operated by just one person. The platform is made of high-quality aluminium and the track carriage, which is fixed in a ball bearing, guarantee easy operation and lateral sliding. The automatic lock and release system prevents the leveller from accidentally dropping. This dock leveller is made of durable weatherproof aluminium alloy and has a load capacity up to 40 kN. It can bridge differences in height of up to 200 mm.



## PHFB - Mobile Dock Plate



The PHFB Mobile Dock Plate is designed to bridge height differences of up to 130 mm. It is made of a durable aluminium alloy and covered with an anti-slip coating. Thanks to its light weight, it can be used for a wide range of applications. On request, this plate can be equipped with rollers allowing it to be moved between different loading positions.

## PQW - Mobile Container Plate



The PQW mobile container plate is best suited for loading and unloading vehicles whose beds have the same height as the loading ramp or are slightly higher than the loading ramp. Using the maneuvering rod, this dock plate can easily be moved to the loading or unloading position by just one person. The PQW dock plate consists of a welded steel structure and shifting of the dock plate is prevented thanks to two movable safety arms. The maximum load capacity of the PQW is 20 kN.

## PQM – Dock Plate



The PQM dock plate has been designed for loading and unloading shipping containers. It compensates the difference in height between yard level and the container bed. It is made of durable welded steel provided with an anti-slip tear plate. This dock plate is provided with lifting points to enable quick and easy transport. For loading and unloading, the dock plate is placed directly next to the rear edge of the container and the lip is swung out and positioned on the container bed. The plate is then secured to avoid slipping away with safety chains.

# DOCK SHELTERS

PROMStahl dock shelters are designed to protect your staff and goods from external environmental factors like wind, rain and sun, as well as to provide a seal between the unloading vehicle and the warehouse to ensure optimal energy use. We offer high-quality mechanical, cushion-type and inflatable shelters. With a focus on design and durability, our shelters are easy to install and can be customised to meet all your requirements.





## **PMV - Mechanical Dock Shelter**

The PMV Mechanical Dock Shelter is an economical solution to seal the gaps which inevitably occur between the docking vehicle and the warehouse opening. The front and the rear frames of the PMV are made up of high-stability extruded aluminum sections which are connected to each other by bracing arms. The curtain is 3 mm thick, made of a highly durable, double-layer of PVC-coated material and is mounted on a flexible frame. Thanks to the adaptable roof and the parallel guide systems the front structure moves backwards in the event of inaccurate docking, helping prevent damage to the dock shelter. The side curtains of the dock shelter come with warning stripes to help with the docking process. An integrated rain channel allows lateral drainage of rainwater (optional).



## **PMK - Mechanical Cushion Seal Dock Shelter**

The PMK Mechanical Cushion Seal is designed for loading and unloading truck fleets with almost identical dimensions in width and height. It guarantees perfect protection from draughts, rain and wind, preventing energy loss. The PMK is equipped with a horizontal cushion and two vertical cushions consisting of foam material completely covered by a PVC-coated high-resistance Trevira fabric. The dimensions of the dock seals are determined depending on the type of loading bay and vehicle to be loaded or unloaded. The PMK dock shelter is pre-assembled and comes in just three parts making installation to the façade quick and easy.



## **PMS - Mechanical Dock Shelter with Side Cushions**

The PMSK consists of a height-adaptable top section and two side cushions. If a vehicle does not dock in perfectly, these foam sidecushions are compressed and then move to the sides, minimizing damage to the dock shelter even if the truck does not reverse squarely. Thanks to the special design of the height-adaptable top section, damage is avoided even for very high trucks like jumbo trucks or demountable containers. If the vehicle height rises during unloading, the roof automatically follows this upward movement and returns to its original position after the vehicle has left the docking station.



# Dock Shelters



## **PWI - Inflatable Dock Shelter**

The PWI Inflatable Dock Shelter combines optimum sealing efficiency with the flexibility of use. It has been designed to allow clients to maximise potential energy savings and who want to protect their goods against adverse weather conditions. The difference in size between the docking vehicle and the warehouse opening inevitably creates a gap and needs to be sealed. Inflatable cushions form a tight seal on the sides and top of the vehicle. This type of shelter is ideal for cold storage facilities and air-conditioned storage rooms. Using this type of shelter can result in significant energy savings, improvement of working and sanitary conditions, helping to increase staff productivity. In addition, unauthorized persons are not able to enter the warehouse unnoticed. Inflatable side and top cushions not only provide effective sealing around the vehicle, but also automatically adjust to the dimensions of the truck allowing an effective seal to be produced on different-sized vehicles.



## **PMN - Alcove-Mounted Dock Shelter**

The PMN Alcove-Mounted Dock Shelter has been designed to be fixed directly to the building alcove as not to disturb the continuity of the building façade and to considerably improve its overall uniform appearance. This type of dock shelter consists of aluminium profiles which are mounted to both sides and to the top edge of the alcove. The shelter can be set in concrete, steel or installed using a special fixing system. The highly durable 3 mm thick curtains are made of 2-layer, PVC-coated material. Warning stripes at the front section of the dock shelter facilitate the vehicle dock-in procedure. The PMN dock shelter is pre-assembled and comes in just three parts, making installation quick, easy and economical.

# LOADING HOUSES

The loading house is an external structure which is combined with the loading ramp and shelter to form a stand-alone docking system that can be mounted externally to the building. They allow the storage space in the warehouse to be maximised and allow the thermal insulation of the building to be maintained.



# PL - Loading House

## PL - Loading House

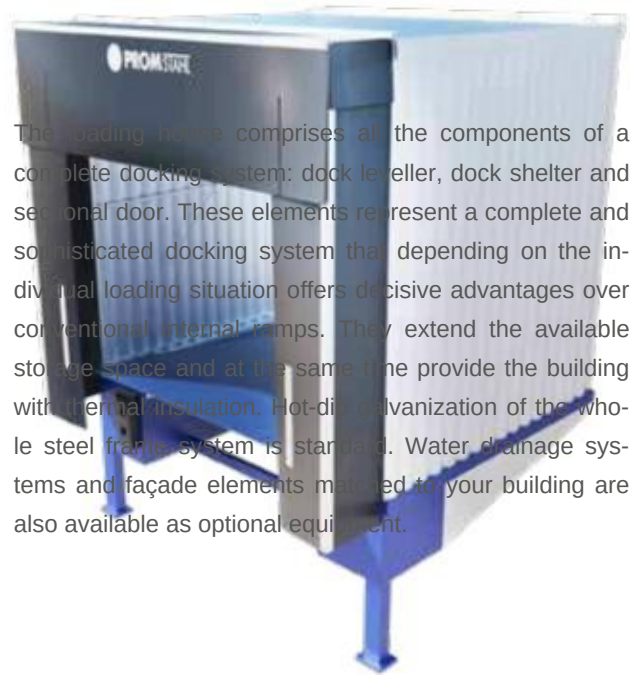

The loading house comprises all the components of a complete docking system: dock leveller, dock shelter and sectional door. These elements represent a complete and sophisticated docking system that depending on the individual loading situation offers decisive advantages over conventional internal ramps. They extend the available storage space and at the same time provide the building with thermal insulation. Hot-dip galvanization of the whole steel frame system is standard. Water drainage systems and façade elements matched to your building are also available as optional equipment.

### Standard parameters:

Nominal length of the loading house (NV):	2000, 2450, 3000, 3500 mm
Dock height (DH):	950-1500 mm
Dock shelter height (structure including insulation) (THI):	3975, 3840, 3640, 4000, 3865, 3665, 4025, 3890, 3690, 4050, 3915, 3715 mm
Dock shelter height (structure excluding insulation) (THU):	3930, 3795, 3595, 3955, 3820, 3620, 3980, 3845, 3645, 4005, 3870, 3670 mm
Loading shelter width (MW):	3300, 3500, 3600 mm
Standard installation angles:	90°, 45°/135°, 75°/105° and 60°/120°. Other installation angles available on request.
Wall types:	U – trapezoidal steel sheet, I – Insulated sandwich panel, X – uncladded

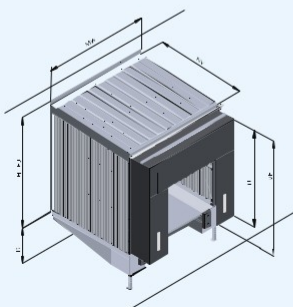



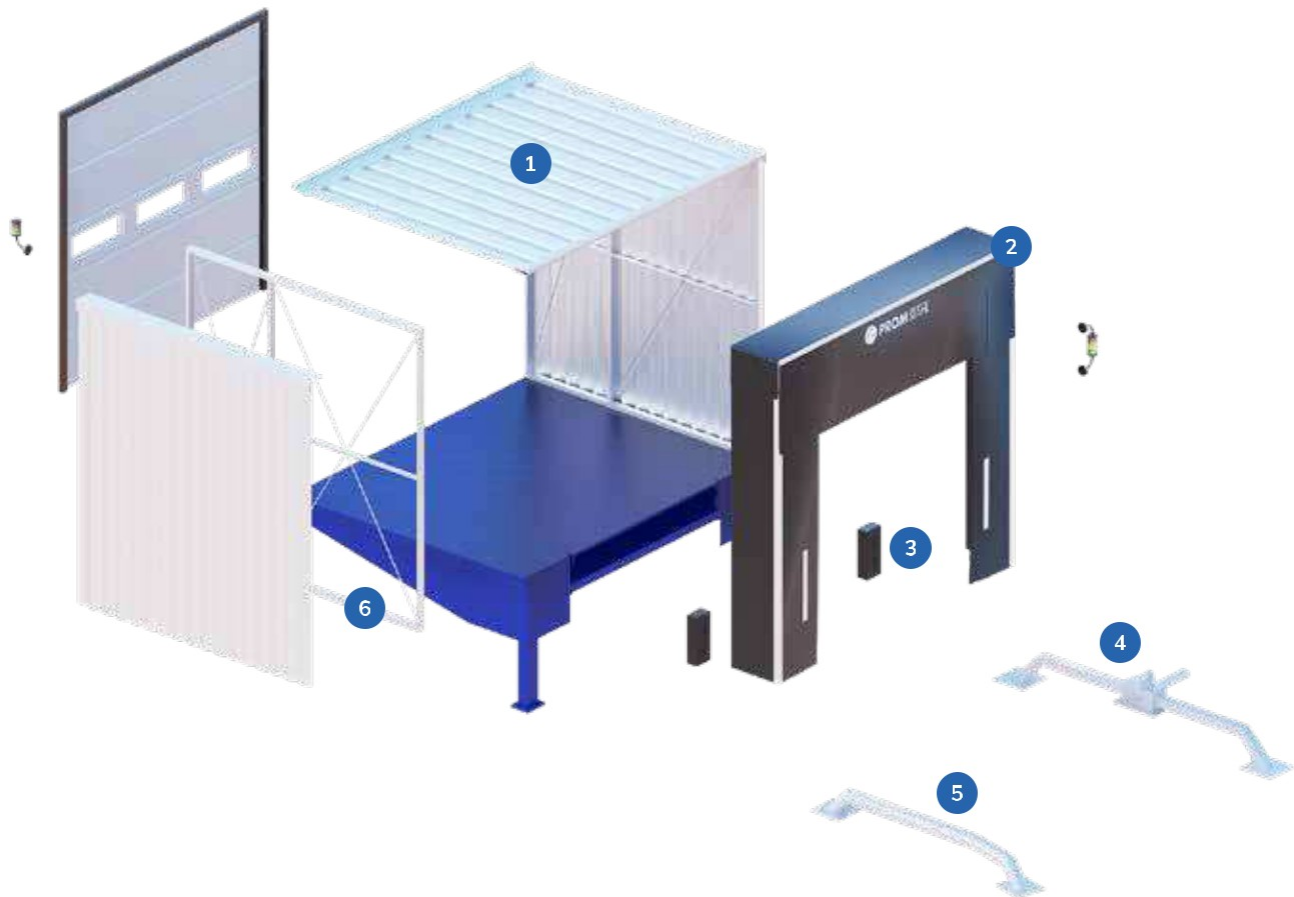

1 The loading house is built with high quality cladding materials:

- trapezoidal metal sheet (standard version)
- sandwich panel (insulated version)

with suitable finishing materials such as flashings and drainage gutters.

Possibility of providing the loading house with a bare frame to be adapted to the architectural design by cladding with other materials.

2 The dock shelter is made of a special composite PVC material with double textile interlace designed specifically for sealing the gap between the loading house and the vehicle. It is highly durable and together with the corrosion-resistant aluminium frame guarantees trouble-free operation.

3 The dock buffers are made of a rubber compound with increased resistance to mechanical damage, and are a durable and economical way to protect the dock.

4 The new GuardBLOCK system prevents the truck from rolling away during the loading and unloading process, preventing the risk of serious injury or accidents.

5 The wheel guides are hot-dip galvanized, without sharp edges designed to allow the vehicle to reverse square to prevent damage to the vehicle or the dock.

6 The loading house frame is made of weather-resistant, galvanized steel profiles which meets the requirements of most wind and snow load zones. It is possible to deliver the structure with customised resistance parameters.

# ACCESSORIES AND OTHER PRODUCTS

PROMStahl is focused on safety and efficiency. With that in mind, we aim to provide every product necessary to make the loading bay fully functional and safe. We have a wide range of accessories including dock bumpers, wheel guides, bollards and docking lights to name just a few.



## PSH - Scissor Lift

The PSH scissor lift is used on loading ramps for loading and unloading vehicles. It compensates for the difference in height between the vehicle and the loading ramp. The PSH is available as a single-scissor or double-scissor system. The robustness of the PSH makes it an excellent choice when comparing the price to performance ratio. Extremely high elevations can be reached by providing the lift platform with several scissor packages. The vertical double-scissor lift, for example, can be used as a working platform, installation table or machinery platform.

## PAR/PARP - Mobile Yard Ramp



The mobile yard ramps are part of PROMStahl's wide product range. They offer the possibility of loading and unloading trucks, containers or wagons directly from yard level. The whole maneuvering and loading process can be managed by just one person. The ramps are made of robust welded steel and the whole driving range consists of stable grids that are optimally dimensioned and suited for heavy loads. For accident prevention the ramp is equipped with lateral protection bars on the left and right side. The mobile yard ramp is available in its standard version (type PAR) or with an additional horizontal platform (type PARP). For loading and unloading of high loads the PARP version is recommended with the forklift truck safely entering the lorry via the horizontal part of the ramp.

## Buffers PBGP, PGF, PEHD, PGB, PGV, PGFS, PGS, PZPS



Buffers are used to absorb the impact of the vehicle at the time of docking to help prevent damage to the dock and vehicle when the vehicle reverses into the loading bay. You can choose from a wide range of buffers:

- PBGP – rubber buffer without steel plate
- PGF – fixed-position rubber buffer
- PEHD – polyethylene buffers
- PGB – floating rubber buffers
- PGV – height-adjustable rubber buffers
- PGFS – rubber buffer with protective housing
- PGS – steel spring buffer
- PZPS – fixed position rubber buffers



# Accessories and other products



## Wheel Guides PEF/PEFE, PEK/PEKE

PROMStahl wheel guides guarantee precise dock-in at the loading bay and avoid expensive damage to dock shelters, levellers, buildings and to the vehicles caused by imprecise docking processes. Thanks to the wheel guides' smooth surface the vehicles' tyres and wheel rims are not subject to any damage. The wheel guides help the truck driver to reverse to the loading bay without requiring any complicated manoeuvring actions. They are installed at yard level, either by being cast into the concrete (types PEK and PEKE) or by being bolted into the ground (flanged version, type PEF and PEFE) and represent a good and reasonable investment in the safety at your loading bay.



## PAFP - Steel Bollards

PROMStahl PAFP bollards are a simple, durable and inexpensive way to limit and secure roads and passage ways. Thanks to their high-stability structure, these bollards may be used as an effective means to protect machines, racks, pillars or building corners against vehicle collisions. All protection bollards are stable, hot-dip galvanized steel structures which are also available with an additional safety paint (yellow and black). They can be used inside and outside. PROMStahl bollards can be safely fixed either by casting them directly into concrete or by bolting them to the ground.



## PV Dock Lights (PV02, PV05, PV07)

In general, the danger of accidents during loading and unloading is very high due to bad lighting of the docking area. PROMStahl dock lights offer the best solution for perfect lighting of the docking area and the vehicle bed.

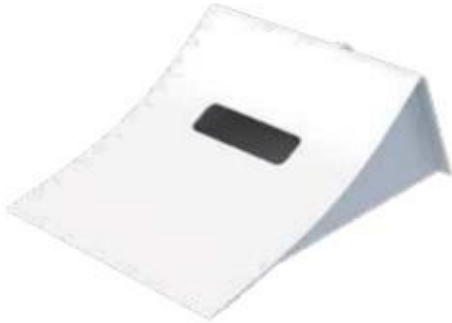

## PZK - Steel Wheel Chock

The PZK wheel chock is equipped with a position-dependent ultrasonic sensor and connected to the control unit via a robust cable. This product guarantees safety during the whole loading and unloading process. As soon as one of the rear wheels of the lorry is blocked by the wheel chock, the leveller control function is “released” so that operation of the dock leveller can be started.



## GuardBLOCK

The manual vehicle restraint system Guard Block optimizes safety during the loading and unloading process. The Guard Block consists of a fixed section anchored to the ground, a mobile section for proper vehicle positioning and locking, and an electromechanical section with external traffic lights for signal processing and signalling. This system eliminates the risk of vehicles leaving the doc-king station accidentally during loading or unloading. The blocking unit is equipped with a sensor and connected to the dock leveller control unit by means of a resistant cable. The dock leveller is re-leased for loading or unloading only after activation of the vehicle restraint system. Furthermore, a special mechanism prevents the deactivation of the blocking system until completion of the loading or unloading process.



## PBEA - Traffic Lights

Internal and external traffic lights are a good product to complete

the safety of the loading dock. It is recommended to provide the loading dock not only with a wheel chock but also with a traffic lights system. The PBEA traffic lights systems assure communication between the vehicle driver and the warehouse staff. They show the driver when the loading dock can be approached and left safely. The traffic lights are connected to the PROMStahl control unit and adjustments/programming can be adapted to suit your individual requirements.

# Choose the best solution



**If:**

- the difference between the loading bay and the vehicle bed is not so large
- you are looking for an economical solution

**PROMStahl can offer:**

PECO-P mechanical dock leveller, PMV dock shelter, PGB buffers (height adjustable) and wheel guides.

**If:**

- there is a significant difference between the loading bay and the vehicle bed
- you are looking for a convenient and easy-to-use solution
- the goods entering the warehouse are heavy
- you need the possibility to dock vehicles with a tail-gate

**PROMStahl can offer:**

PS or PT hydraulic dock levellers, a PMV dock shelter and PGB buffers and wheel guides.



**If:**

- your building stores goods at low temperatures
- maximum reduction of Energy loss is important
- you want to adapt your loading bay to suit vans and lorries

**PROMStahl can offer:**

a PTU hydraulic dock leveller with 1000mm segmented telescopic lip, an ISO KIT, a PMV dock shelter, PGB buffers and wheel guides.

**If:**

- an air-tight seal around the vehicle is important
- you are looking for an interesting design
- you want to adapt your loading bay to suit vans and lorries

**PROMStahl can offer:**

a PTU hydraulic dock leveller with 1000mm segmented telescopic lip with a stepped frame, an ISO KIT, a PWI pneumatic dock shelter, PGB buffers and wheel guides.







**If:**

- the difference between the loading bay and the vehicle bed is not so large
- you are looking for an economical solution

**PROMStahl can offer:**

PECO-P mechanical dock leveller, a PMV dock shelter, PGB buffers (height adjustable) and wheel guides.

**If:**

- you need to maximise the space in the warehouse
- you need to maintain the thermal insulation of the building

**PROMStahl can offer:**

a PL loading house, a PAS or PAT loading ramp with a hydraulic dock leveller, a PMV dock shelter, PGB buffers and wheel guides.



**If:**

- minimal energy loss is important
- you want to open the warehouse door after the vehicle docks

**PROMStahl can offer:**

a PL loading house, a PAT loading ramp with a hydraulic dock leveller including a 1000mm telescopic lip and stepped frame, a PMV dock shelter, PGB buffers (height adjustable), a movement sensor and wheel guides.

**If:**

- maximising your storage area is important
- you need to maintain the thermal insulation of the building
- you want to increase the safety of your loading bay by restraining the docked vehicle

**PROMStahl can offer:**

a PL loading house, with a PMV dock shelter, PGB buffers and wheel guides including GuradBLOCK.





## OUR CERTIFICATES

**TUV NORD**

### ZERTIFIKAT CERTIFICATE

Always and everywhere, also the Form: This certifies that the company

**PROMStahl GmbH**  
Ronnenberger Straße 20  
30999 Gehrden  
Deutschland

Inspektion von: Also, enter general Product and item identification Zeichen /y/ Kennzeichen  
is authorized in principle for product identification below with the start as described

Partigungsstelle: **PROMPRZEW S.A.**  
Manufacturing plant: **ul. Szosa Kozłowska 35  
88-918 Kowalewo  
Pole.**

Bezeichnung des Produktes: **Klappkühlerische P5621.112**  
(Anlage s. Anlage 1)  
Description of product: **Werschückerische P5221.142**  
(siehe see Anlage 1)

Geprüft nach: **DIN EN 1384 2009 - Leberlecken**  
Tested in accordance with:

Das Produkt entspricht den Anforderungen des Produktsicherheitsgesetzes (ProdSG § 21)  
The product conforms with the requirements of the Product Safety Act (ProdSG § 21)

Regulation Nr. / Registration No.: **41.325.1819020**      Gültigkeit / Validity: **von / from 2016-01-13**  
Zertifikats-Nr. / Certificate No.: **2016.81468 / 16.324.031837**      bis / until: **2021-01-13**  
Anmerkungen / Remarks: **98800010037**

**TUV NORD CERT GmbH**  
Zertifizierungsstelle Muenchen

Seite: 2/16-01-13

**TUV NORD CERT GmbH** | Langenackerstraße 26 | 95244 Euerth | www.tuv-nord-cert.de | info@tuv-nord.de

**TUV NORD**

### ANLAGE ANNEX

Anlage 1, Seite 1 von 1  
Annex 1, page 1 of 1

zum Zertifikat Registrier-Nr. / to Certificate Registration No.: **44 326 15116701**

<b>Allgemeine Angaben</b> General Information	Siehe Seite 1 des Zertifikates See also page 1 of the Certificate
<b>Typbezeichnung</b> Type designation	<b>Klappkühlerische P5</b>
<b>Werkstoffbezeichnung</b> Material designation	<b>Werschückerische P5</b>
<b>Nennspannung</b> Nominal Voltage	<b>400 V 3 N PE</b>
<b>Nennfrequenz</b> Nominal Frequency	<b>50 Hz</b>
<b>Nennleistungsbereich</b> Nominal Power Range	<b>1,71 kW (Standard) 1,3 kW (nach Anbaukasten)</b>
<b>Netzanschluss</b> Main connection	<b>Zum überführen Anschluss an die feste Installation</b>
<b>Spannungsfeld</b> Voltage	<b>Bestimmte Leiterdröcken mit elektrodynamischer Anlehn</b>
	<b>Klappkühlerische P5</b>
	<b>Stigkraft: 60 kN</b>
	<b>Nennlänge: 1500 - 4500 mm</b>
	<b>Nennbreite: 1150 mm, 2000 mm, 2200 mm</b>
	<b>Klapphöhe: 400 mm, 500 mm</b>
	<b>Werschückerische P5</b>
	<b>Stigkraft: 60 kN</b>
	<b>Nennlänge: 2000 - 3500 mm</b>
	<b>Nennbreite: 1750 mm, 2000 mm, 2200 mm</b>
	<b>Werschückerhöhe: 500 mm, 1000 mm</b>

**TUV NORD CERT GmbH**  
Zertifizierungsstelle Muenchen

Seite: 2/16-01-13

**TUV NORD CERT GmbH** | Langenackerstraße 26 | 95244 Euerth | www.tuv-nord-cert.de | info@tuv-nord.de



**MODERN MACHINERY**

**PROFESSIONALLY QUALIFIED STAFF**

**INTERNATIONAL CONTRACTS**



**SIA R.A.S.A. un Ko**

**Tel.67860007**

**E-pasts: [info@rasa.lv](mailto:info@rasa.lv)**

